

BODY COMPOSITION ANALYZER

MC-780MA

Instruction Manual

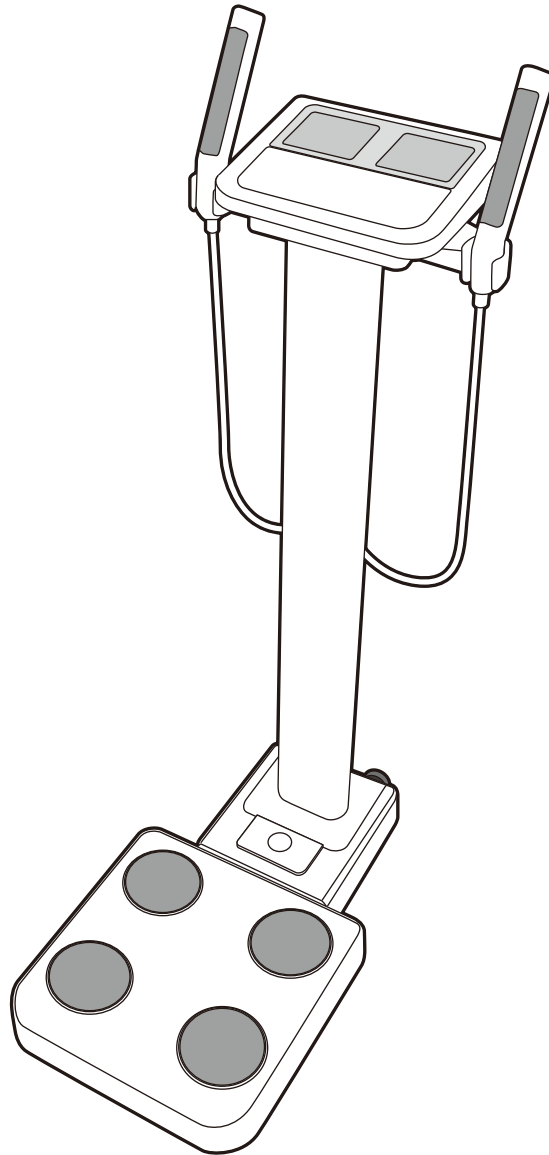

<Usage Conditions>

Temperature	: 5°C – 35°C
Relative Humidity	: 30% – 80% (without condensation)
Maximum Altitude	: 2,000m ASL
Pressure	: 86kPa - 106kPa

<Storage Conditions>

Temperature	: -10°C – 50°C
Relative Humidity	: 10% – 90% (without condensation)
To avoid malfunctions, avoid storing the equipment in a place with direct sunlight, significant temperature changes, a risk of dampness, a large amount of dust or a risk of vibration or impact, or in the vicinity of flames.	



Please read this Instruction Manual carefully and keep it for future reference.

Intended Use

- This equipment can be used in the screening of certain adult diseases and conditions related to body weight and composition.
- The equipment can be used in the monitoring and prevention of conditions caused by excessive deposits of fatty tissue such as diabetes, hyperlipidemia, cholelithiasis (gallstones) and fatty liver.
- The equipment can be used in the monitoring of changes in individuals' body composition related to the ratio of fatty tissue to lean tissue.
- The equipment can be used to assess the effectiveness of individuals' nutrition and exercise programmes for health and physical fitness.

Efficacy

1. This product is simple to use, and requires no specialized facilities or expertise is required to take measurements.
2. Measurements can be taken quickly and easily, causing minimal inconvenience to the patient during measurement.



Contents



Before Use

For Your Safety	4
Part Names & Connection	8
Preparation	10
Power Supply	14
Settings	15

How to Use

Taking a Measurement	17
Body Composition Mode	17
Measurement Results	19
Scale Mode	21
Weight Lock Mode	22
Output and Storage of Measurement Results	23

If Necessary

Troubleshooting	25
Specifications	26

For Your Safety

GB

Before Use
(cautions for safety)

This section explains precautionary measures to be taken to avoid injury to the users of this device and others, and to prevent damage to property. Please familiarise yourself with this information to ensure safe operation of this equipment.

 **Warning** Failure to follow instructions highlighted with this mark could result in death or severe injury.

 **Caution** Failure to follow instructions highlighted with this mark could result in injury or damage to property.



This mark indicates actions that are prohibited.



This mark indicates instructions that must always be followed.

Warning



Prohibited

This equipment must not be used on subjects with pacemakers or other mechanical implants.

This equipment passes a weak electrical current through the body which could interfere with and cause the malfunction of electrical medical implants, resulting in serious harm.



Do not handle the plug with wet hands.

This may result in electric shock, fire, or leakage.



Keep this equipment away from flammable gas and oxygen-rich environments.



Do not modify this equipment in any way.

This can cause electric shock or injury, or affect the accuracy of analysis.

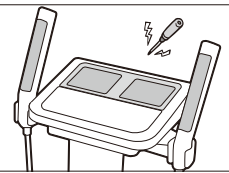

Do not use a multi-plug adapter.

This may cause fire.

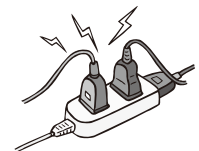

Caution



Prohibited

Keep away from water.

Avoid using on subjects with metal allergies.

Allergic reactions may be caused by the stainless steel used in the electrodes of this device.

Do not jump on the equipment.

Do not lean on the equipment.

Do not use this equipment near other products that emit electromagnetic waves.

Do not insert fingers into gaps or holes.

Do not apply force to the display.

The screen panel may break and cause injury.

Do not place items sensitive to magnetic forces near the equipment.

The magnet of the impedance meter may cause corruption of data on devices such as floppy disks and USB memory sticks if these are placed near the equipment.

Assist persons with disabilities.

Another person must perform measurements for persons with disabilities that impair their ability to do so alone.



Always...

Be sure to clean the scale platform with appropriate disinfectant after each use.

Stand clear of the subject during measurement to avoid electric shock and ensure accuracy.

Continually monitor both the subject and the equipment for anomalies.

If an anomaly in the subject or equipment is discovered, take appropriate action, such as stopping the equipment, while ensuring the safety of the subject.

Be sure to use the included AC adapter. (TR30M120)

Do not lean against the equipment.

Unplug the AC cable from the equipment when moving it.

Tighten the adjustable feet when moving the equipment.

Interpretation of analysis results (e.g. evaluation of measurements and formulation of exercise programmes based on results) must be performed by a professional.

Weight loss measures and exercise based on self-analysis could be detrimental to you health. Always follow the advice of a qualified professional.

This equipment is designated a Class B IT device (mainly for systems intended to be used in domestic environments) and is CE (EMC) certified, but it may affect devices that are sensitive to electromagnetic waves.

If connecting a computer or peripheral devices to this equipment, please use devices complying with IEC60601-1 (EN60601-1). Power must be supplied from a medical isolation transformer for IEC60950(EN60950) devices. Keep a distance of 1.5m between units during operation. Failure to do so may cause electric shock to subjects or malfunction.

For Accurate Measurements

Avoid measuring after strenuous exercise.

This may cause inaccurate measurements. Please take measurements after sufficient rest.



Avoid measuring after excessive food or fluid intake or when dehydrated.

This may cause inaccurate measurements. For greater accuracy, avoid using directly after waking up. Use at the same time on each occasion, at least three hours after a meal.

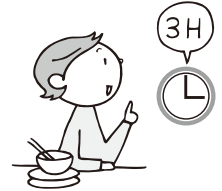

Ensure that your arms are not touching your sides and that your inner thighs are not touching each other during measurement. If necessary, place a dry towel between your arm and side and/or between your thighs.

Do not take measurements while using transmitting devices, such as mobile phones, which may affect readings.

Use the equipment under the same conditions and in the same position as much as possible for accurate tracking of changes.

Readings are greatly affected by the level of hydration and position of the body. Please use at the same time of day each time, under the same conditions and in the same body position.



Avoid measuring in multiple locations with greatly differing temperatures.

This may cause inaccurate measurements. Allow the equipment to stand for at least 2 hours before using if it is moved to a new location with a temperature difference of 20°C or more.



Make sure the soles of your feet are free of excess dirt, as this may block the mild electric current.

Always hold both arms straight down when taking measurements to prevent measurement errors such as undermeasurement of body fat.

**Bare feet should be placed correctly on the electrode platform.
Place arms straight down during measurement.**

Use in a stable location.

Errors in measurements may occur if the device is used in an unstable location.

Scheduled Maintenance

TANITA recommends that each facility conduct periodic checks of each unit.

1. Check the following at least daily:
 - That the unit is on a stable and level surface
 - Date and time settings
2. Visually inspect the following at least weekly:
 - The display for any damage or contamination
 - All cables, cords, and connector ends for damage or contamination
 - All safety-related labeling for legibility
 - All accessories (sensors, electrodes, etc.) for wear or damage
3. Visually inspect the following at least monthly:
 - Mounting screws on stand

Update settings, replace items, or call for service as necessary according to the results of the visual inspections. Do not use the unit if you see any signs of damage. Equipment that has been damaged must be checked for proper operation by qualified personnel before using again.

Part names & Connection procedure

GB

Before Use
(cautions for safety)

Symbols and their Meanings

	Positive polarity		Serial interface
	Conformity with Medical Device Directive 93/42/EEC		Direct current
	Alternating current		Class II Equipment
	Input, Output		Type BF applied part - Grips and platform
	Date of manufacture		WEEE - Waste Electrical and Electronic Equipment Directives
	Caution Refer to the attached notes.		For indoor use only
	SD card		See the instructions

*The SD logo is a registered trademark of the SD Association.

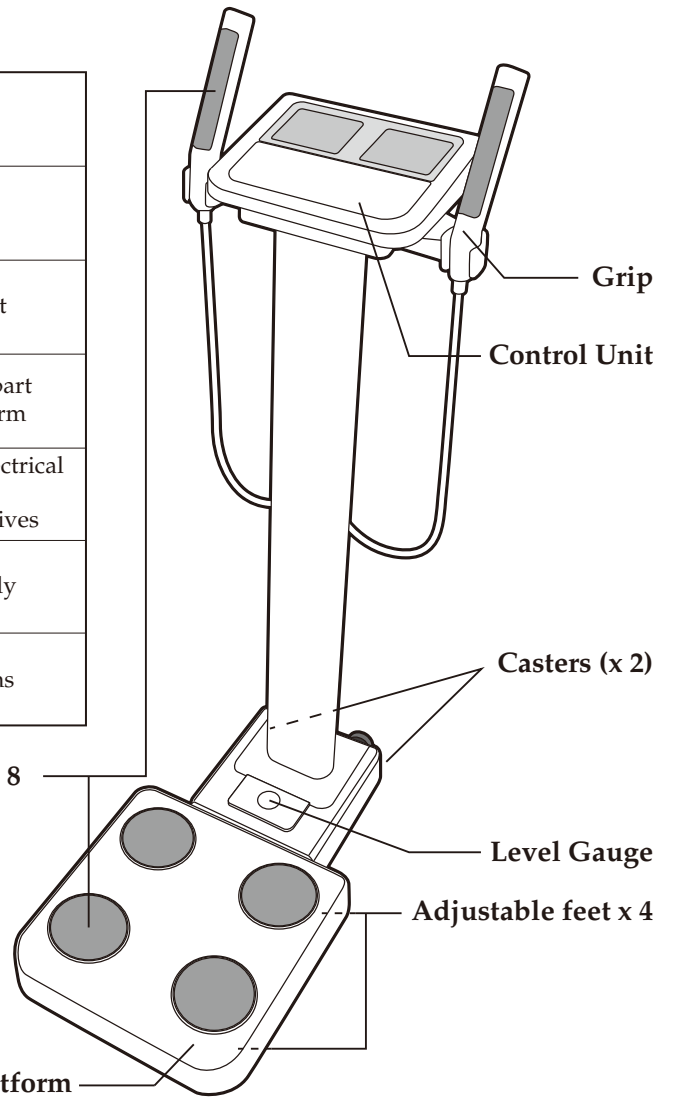

Checking the level

- * For accurate measurement, place the machine as level as possible.
- * Rotate the adjustable feet in 4 positions for adjustment so that the bubbles of the level gauge reach the centre.

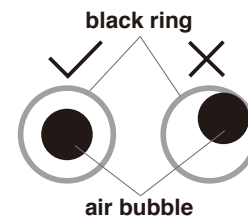

Status when the level gauge is viewed from above

Control unit Connection of Plugs

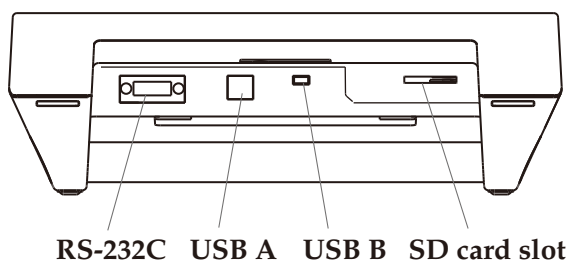

Platform Connection of Plugs

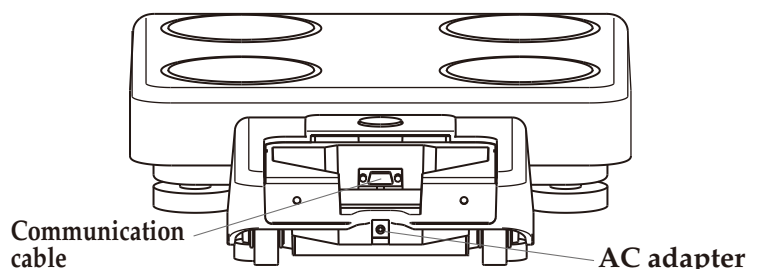

Display and Keys

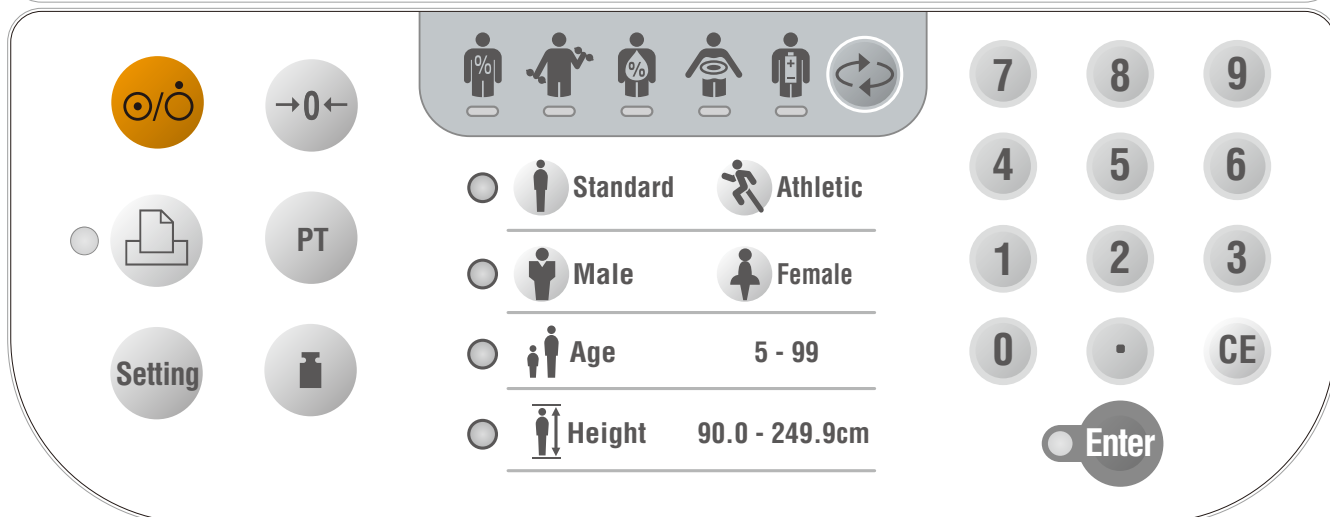
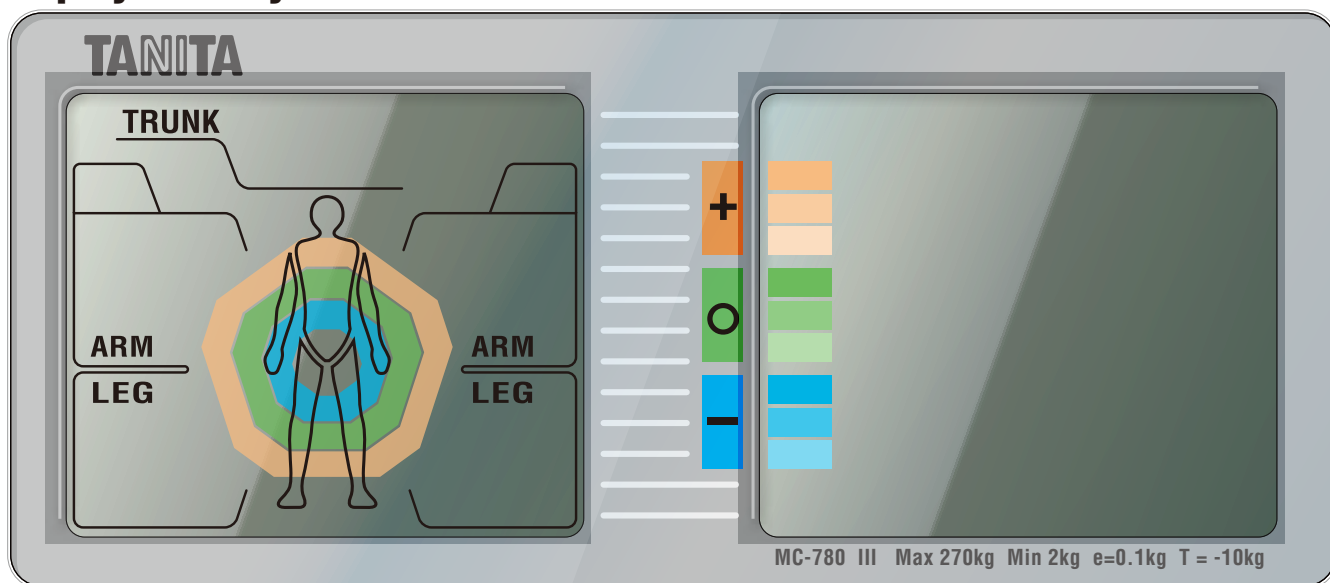

Meanings of the LED Indicators and Keys

	Turn ON / OFF the power
	Printout result
	Set various functions
	Reset zero point
	Set preset value (Clothes weight)
	Select measurement mode

	Display Body Fat (percentage and mass) *Not measured value but calculated value		
	Display Body Muscle (percentage and mass) *Not measured value but calculated value		
	Display Body Water (percentage and mass) *Not measured value but calculated value		
	Display Visceral Fat Rating		Display Basal Metabolic Rate
		Indicates whether "Standard mode or Athletic mode" is selected as the body type.	
		Indicates whether "Male or Female" is selected as the gender	
	5 - 99	Enter the age between "5 - 99 years"	
	90.0 - 249.9cm	Enter the height between "90.0 - 249.9 cm"	
	Confirms the entered numerical value.		

Assembly

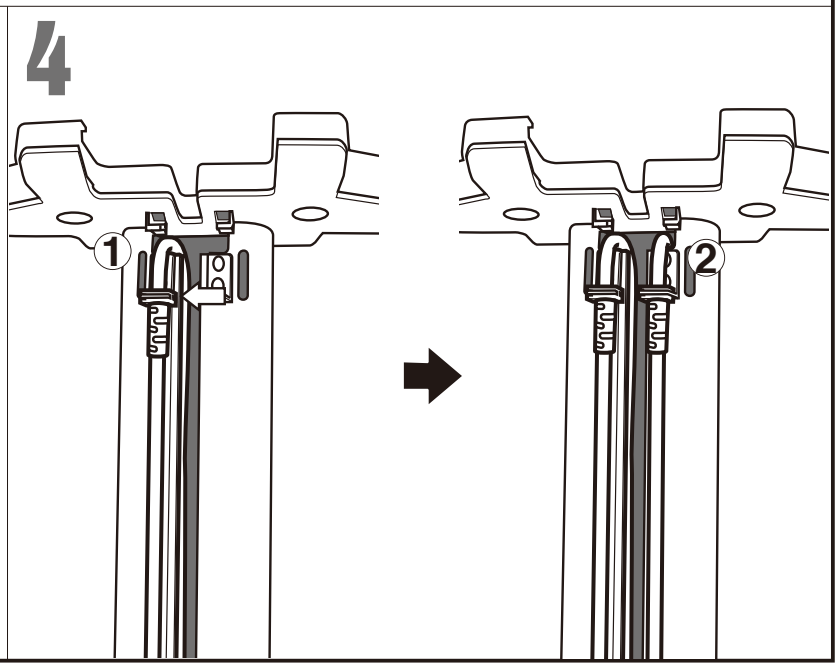
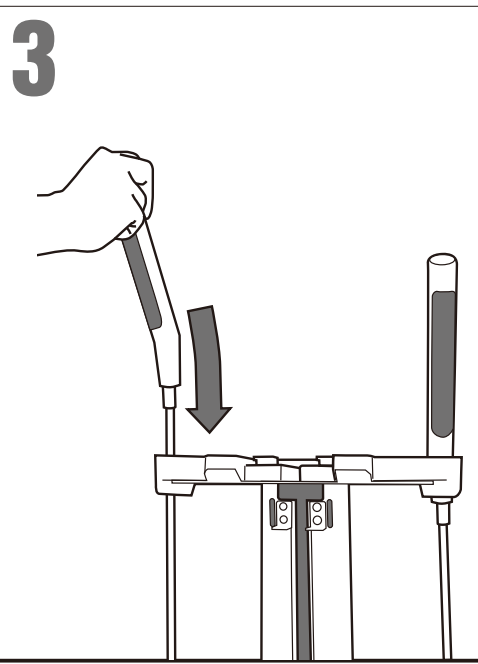
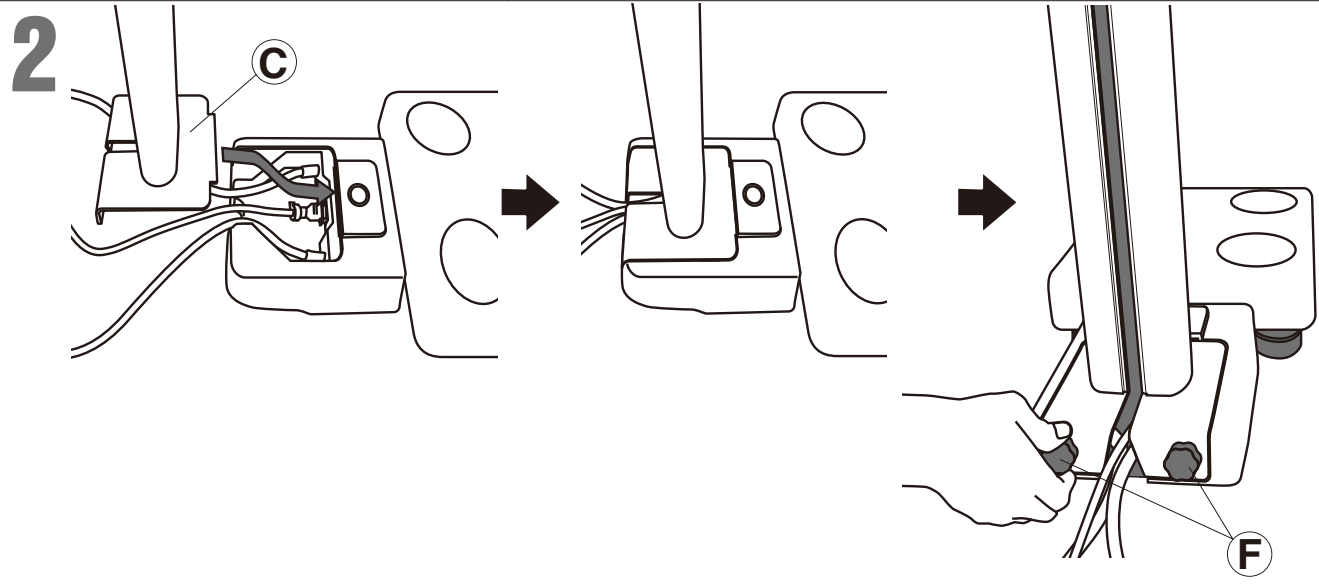
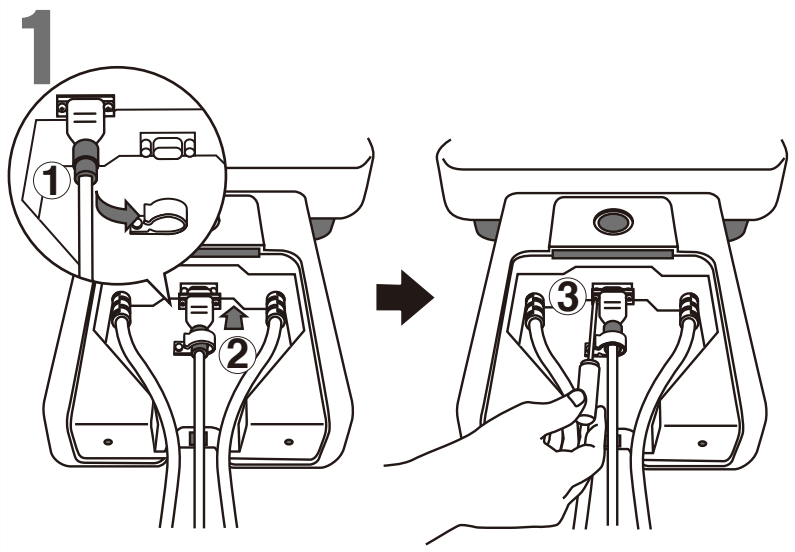
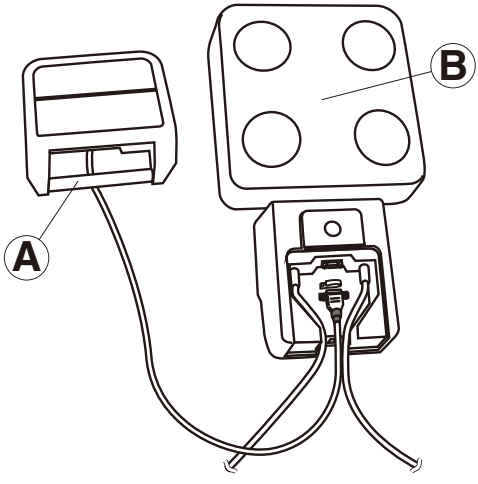

Preparation

Setting up the mainunit

GB

Before Use
(cautions for safety)

Assembly (continued)

5

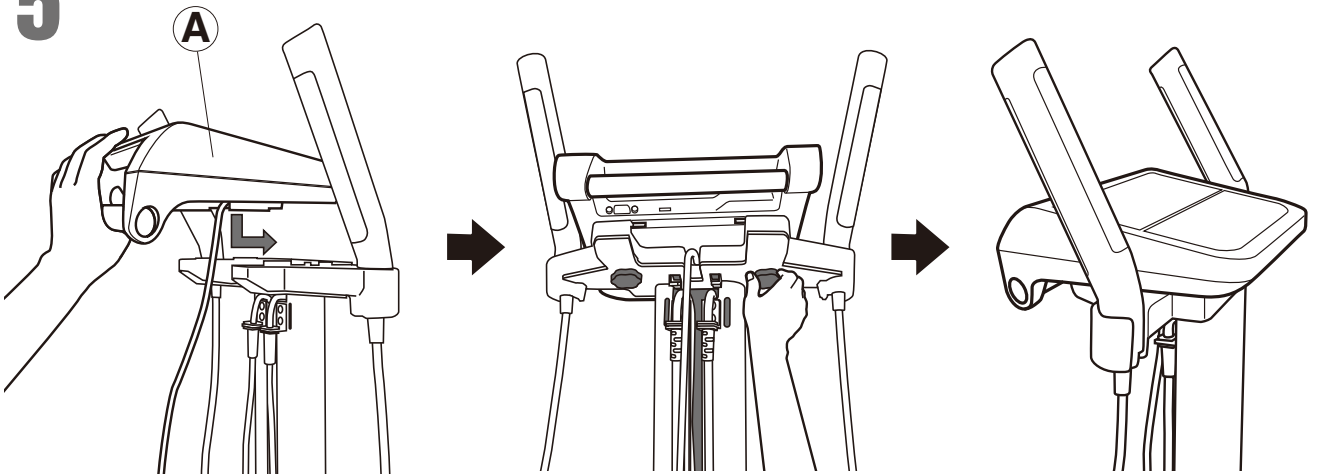

6

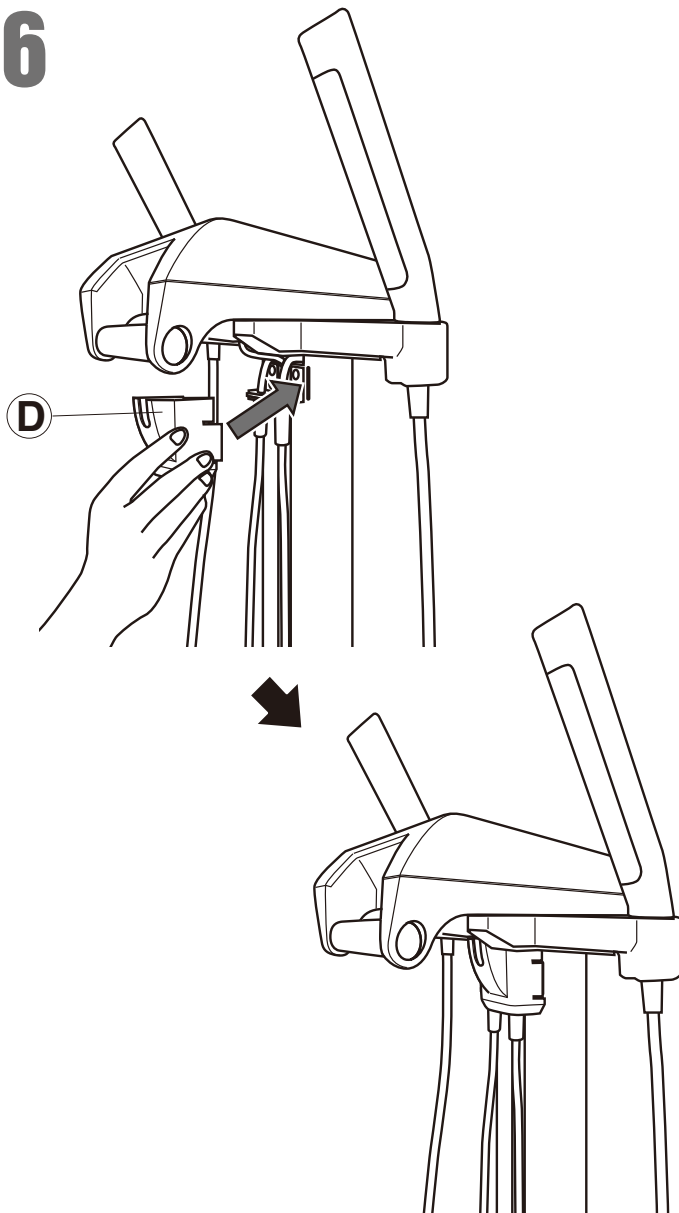

7

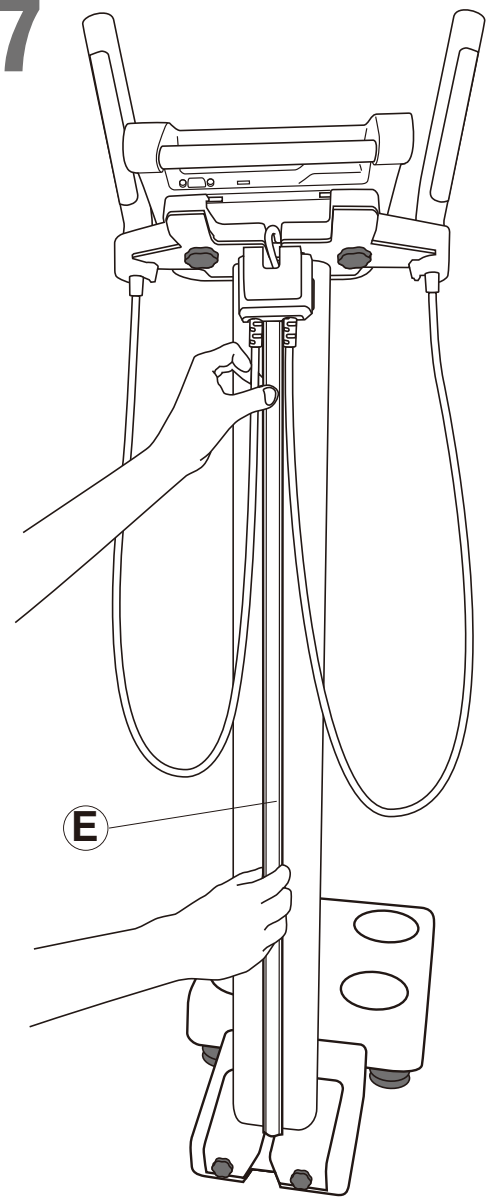

Assembly (continued)

8

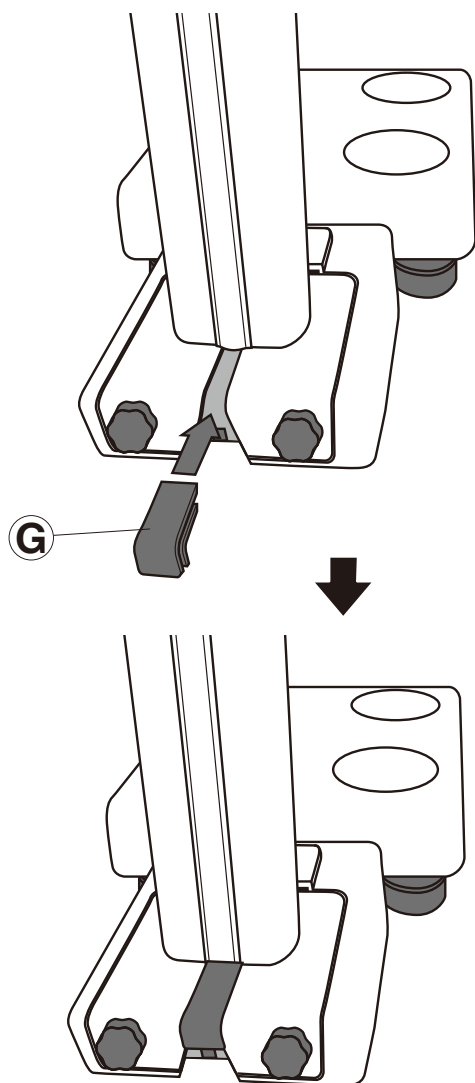

9

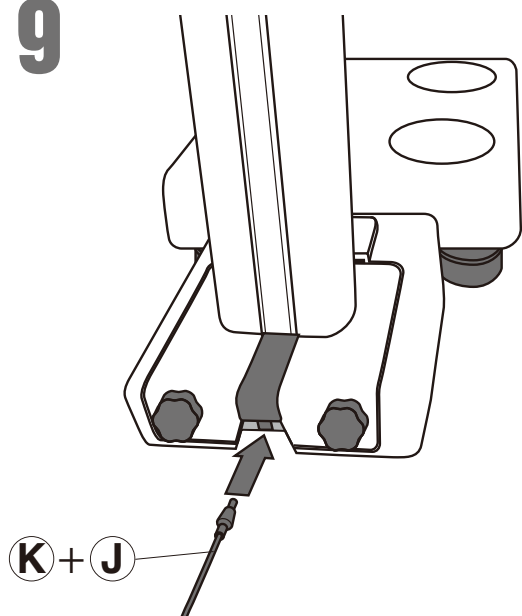

10

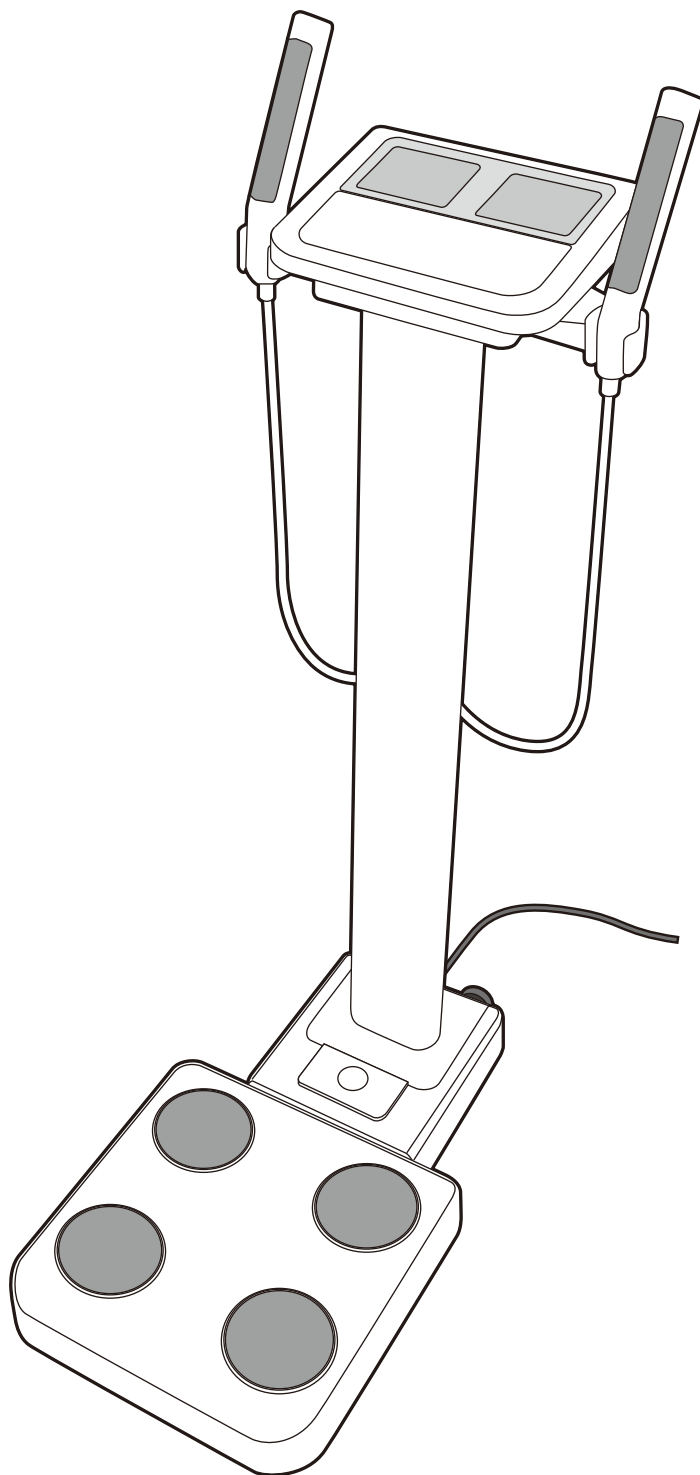

Power Supply

GB

Before Use
(cautions for safety)

Turning the main power ON/OFF

Turning the main power ON.

Press the  key to turn on the power.

The initial screen is displayed.

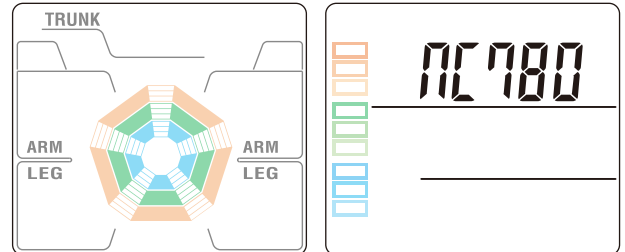

Turning the main power OFF.

Press the  key to turn the power off.

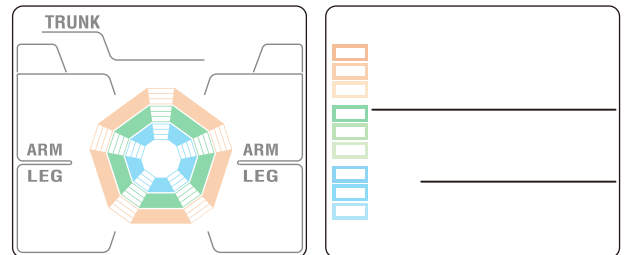

Emergency Shut Down

Keep the area around the plug socket clear during operation of the equipment in case of an emergency.

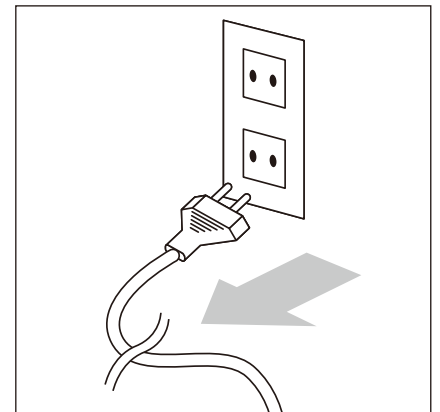

1 Press the  key to change the mode.

The setting screen is displayed.

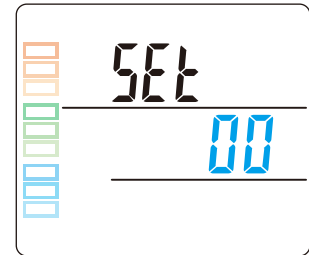

Note

•The  key cannot be used when the scale is measuring weight or impedance.

2 Select the setting item from the list below.
Enter numerical values and Press the  key.

Setting item List  → Save changes and return  → Return without saving

0	Check the software version	10	Height input unit (0: 0.1cm increments 1: 1cm increments)
1	Date and time * Date and time → Note	11	Automatic determination time of input information (0-9 second(s)) * 0: Disables this function
2	Number to be printed automatically (Body composition mode) (0-2 sheet(s))	18	Target body fat ratio input (0: off 1: on)
3	Number to be printed automatically (Scale mode and Weight lock mode) (0-2 sheet(s))	19	Printout language (1: English, 2: French, 3: German, 4: Italian, 5: Spanish)
4	Select printing paper (0: Pre printed paper 1: Plain paper)	20	Adjut printing position (2 : ↓ , 4 : ← , 6 : → , 8 : ↑)
5	Beep sound (0: off 1: on)	21	Timeout function of result display (0: disable 1: enable)
6	ID number (Manual input) (0: off 1: on)	30	Data output format to PC (0: default format 1: BC-418 format)
7	ID number (Automatic count up) (0: off 1: on)	31	Display direction (0: default 1: reversal position)
8	Measurement flow (0: Two step flow (Measure body weight first) 1: One step flow (Enter personal information first) * Measurement flow → P.17	32	BMI desirable range (0: 18.5 to 25 1: 18.5 to 23)
9	Body type selection (Athletic mode) (0: off 1: on) * Athletic mode → P.24	60	Reading mesurement result

Note

Enter the year, month, day, hour and minute.
The date format is "yyyy mm dd hh:mm"

Example 6:47 pm, 24th September, 2012
"2012" "09 24" "18:47"

To enter a number with 1 digit (0 – 9), press "0" first.

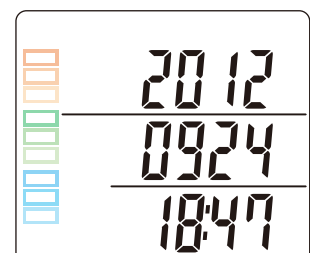



Settings (continued)

Select the Measurement Mode

Select the measurement mode by pressing the  key.

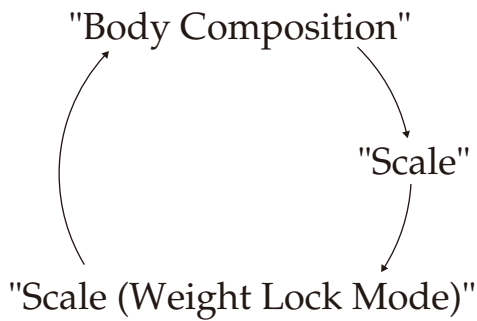
The measurement mode is switched in the following order when the  key is pressed:



The "" mark is displayed when the scale mode is selected.

Body Composition Mode

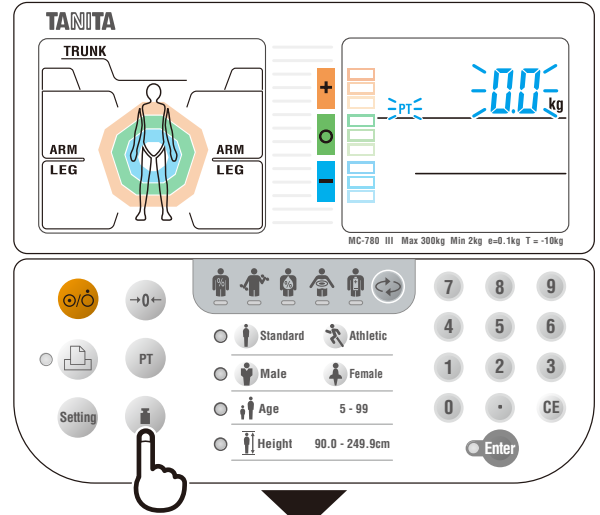

Scale Mode

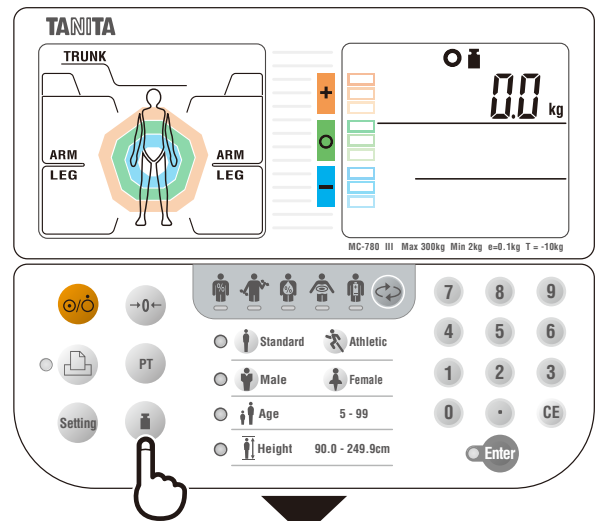

Scale Mode (Weight Lock Mode)

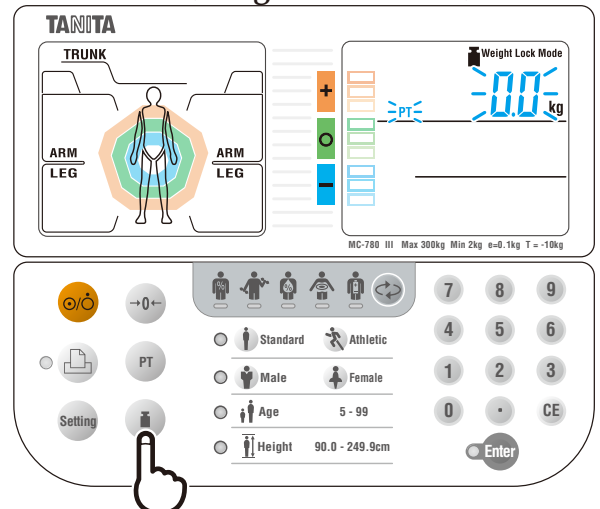

Taking a Measurement

Body Composition Mode

1 Enter the preset tare value (clothes weight)

Turn the power on, and check that the "PT" mark is displayed.

Enter the preset tare value (clothes weight)

The tare value range is 0.0 - 10.0kg

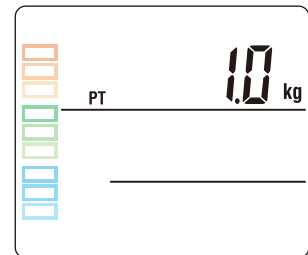
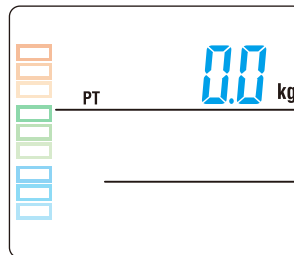

2 Measure body weight

Wait until "STEP ON" flashes.

"NET" is displayed when you have entered a tare value (clothes weight).

Note

If the scale does not detect a load, press **PT** to switch to "Input tare value".

If the scale detects the load, press **PT** to display the entered tare value.

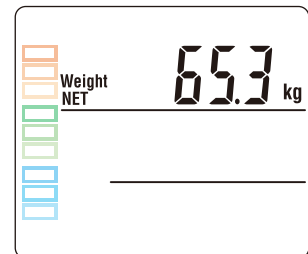
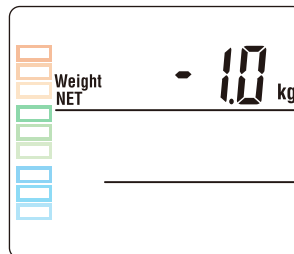

3 Enter ID number

If the ID number function is set to OFF, the scale switches directly to "Select body type" without requesting an ID number.

The ID number range : 0 - 9999999999999999

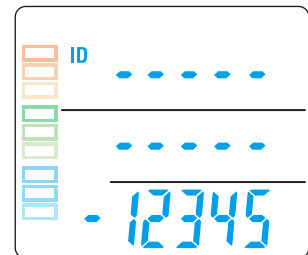

4 Select body type Standard Athletic

If the body type selection (Athletic mode) is set to OFF, the scale switches directly to "Select gender" without requesting a body type.

The "" mark is displayed when the Athletic mode is selected.

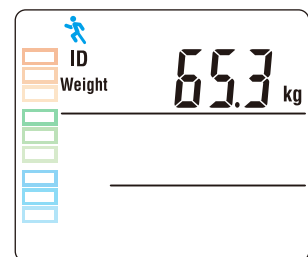

Note

Athletic Mode → P.24

Taking a Measurement (continued)

GB

Body Composition Mode

5 Select gender  Male  Female

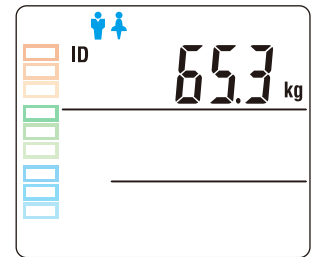

6 Enter age  Age

The age range : 5 - 99

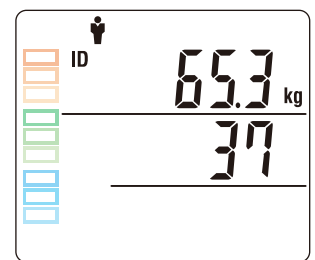
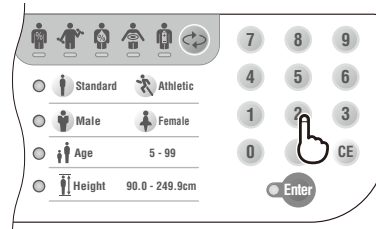

7 Enter height  Height

The height range : 90.0 - 249.9 cm

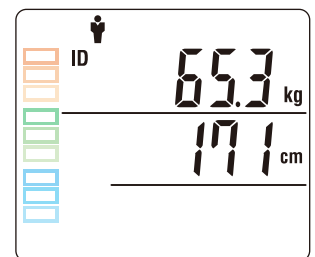
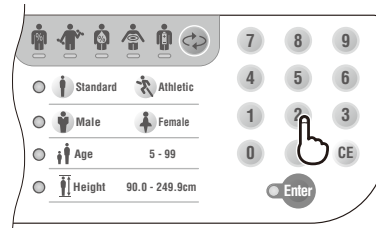

8 Set target body fat ratio

If the target body fat ratio function is set to OFF, the scale switches directly to "Measuring impedance" without entering the target value.

The body fat ratio range : 4 - 55 %

Note Target Body Fat → P.24

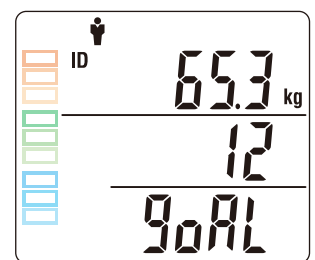

9 Measuring body composition

The scale starts measuring impedance after you have entered all of the personal information.

The segmental impedance values are measured in order.

The scale displays the measurement results after measuring the whole body impedance and segmental impedance.

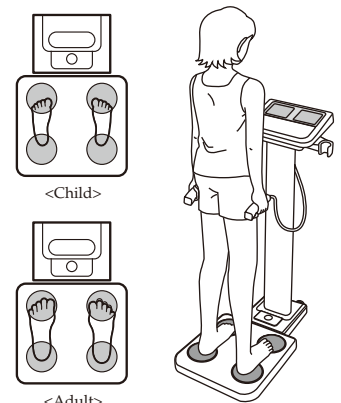

How to Use
(cautions for safety)

Measurement Results (Body Composition Mode)

Output Measurement Results (Body Composition Mode)

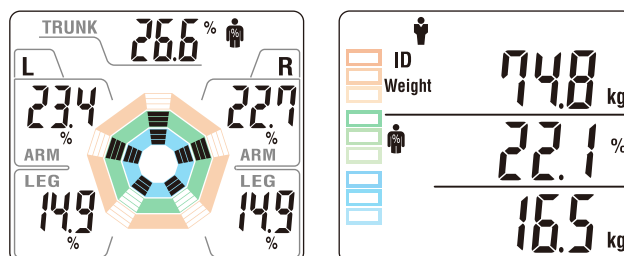

The measurement results are displayed on the LCD after measurement is completed. The results are output to the PC immediately after measurement is completed.

Press the key to select the measurement display.

The measurement display is switched in the following order by pressing the key.

"Fat" → "Muscle" → "Body Water" → "Visceral fat rating" → "Basal metabolic rate" → "BMI"

Fat

Fat mark

Segmental fat %

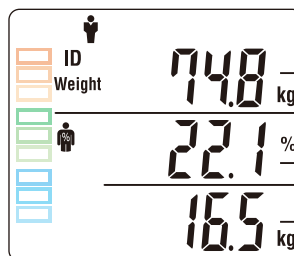
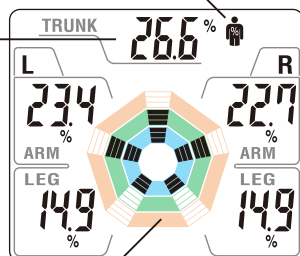

Body weight (kg)

Body fat %

Body fat mass (kg)

Evaluation of your results compared to average values.

Muscle

Muscle mark

Segmental Muscle Mass

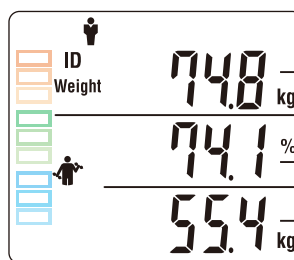
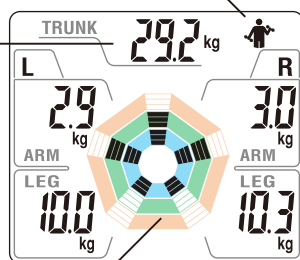

Body weight (kg)

Body muscle %

Body muscle mass (kg)

Evaluation of your results compared to average values.

Taking a Measurement (continued)

GB

Measurement Results (Body Composition Mode)

Body water

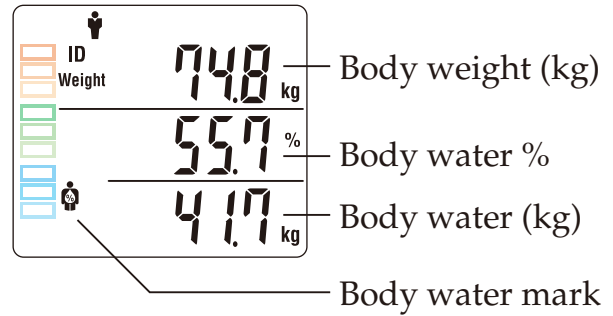

Visceral fat rating

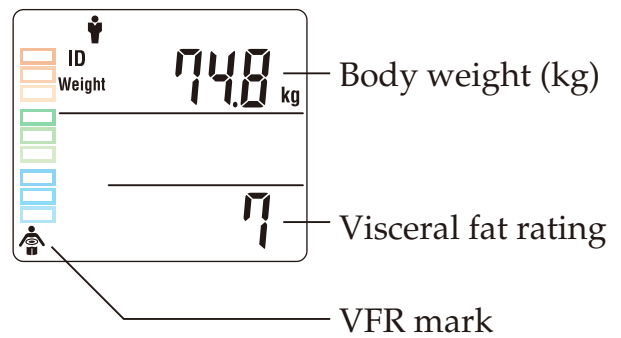

Basal metabolic rate

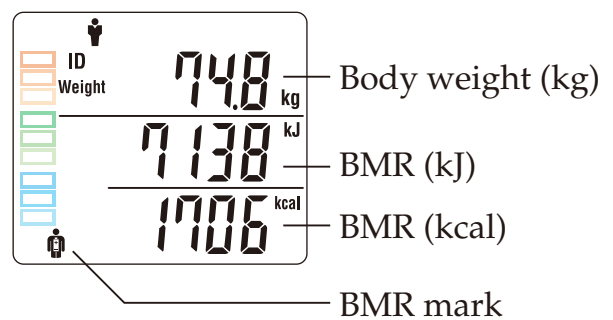

BMI

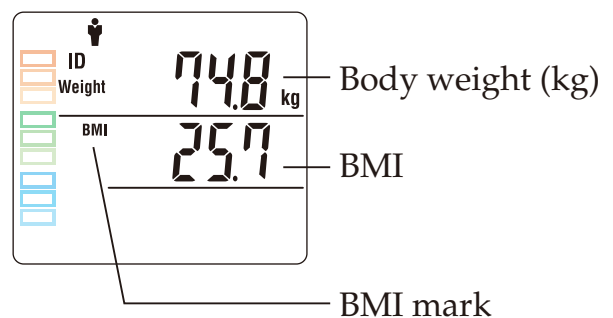

How to Use
(cautions for safety)

Scale Mode

The "■" mark is displayed when the scale mode is selected.

1 Enter the ID number

If the ID number function is set to OFF, the scale starts measuring your weight immediately.

Enter the ID number.

The ID number range is from 0 to 9999999999999999.

Press **PT** to enter tare value (clothes weight).

The tare value range is 0.0 - 10.0kg.

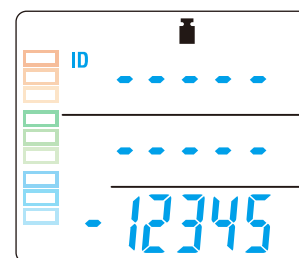

2 Measure body weight

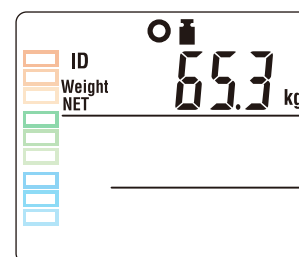
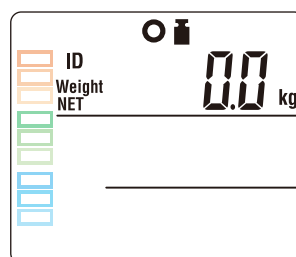

Wait until "STEP ON" flashes.

"NET" is displayed when you have entered a tare value (clothes weight).

The "Stabilised" mark (●) appears when the load is stable.

The "Stabilised" mark (○) disappears when the load is unstable.

When the load is stable, the measurement results are output via the USB port and stored on an SD card.

Taking a Measurement (continued)

GB

Weight Lock Mode

The "🔒" mark and "Weight Lock Mode" are displayed when the weight lock mode is selected.

Enter the preset tare value (clothes weight)

The "PT" is displayed after the scale mode is selected.

Enter the preset tare value (clothes weight)
The tare value range is 0.0 - 10.0kg.

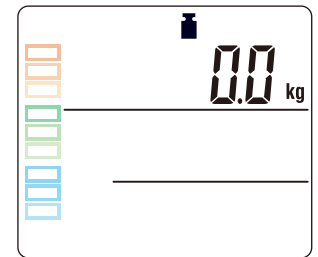
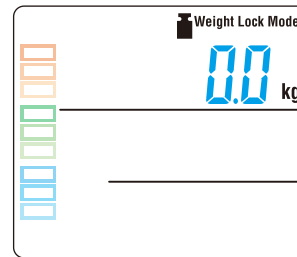

Enter the ID number

If the ID number function is set to OFF, the scale starts measuring your weight immediately.

Enter the ID number.
The ID number range is from 0 to 9999999999999999.

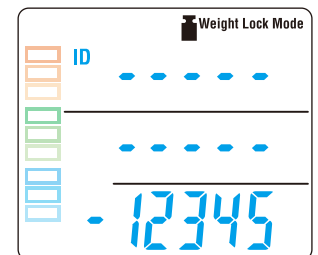

Measure body weight

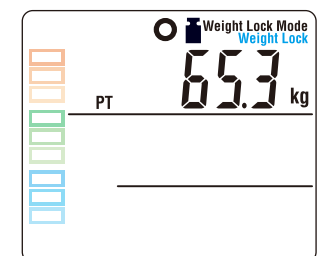
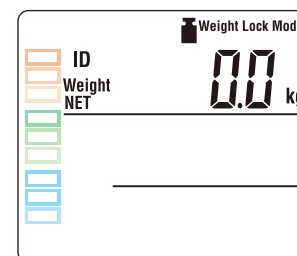

* "NET" is displayed when you have entered a tare value (clothes weight).

How to Use
(cautions for safety)

Output and Storage of Measurement Results

Data Output

Outputting measurement results via the USB port

The results are output to the PC immediately after measurement is completed.

Data is output in CSV format.

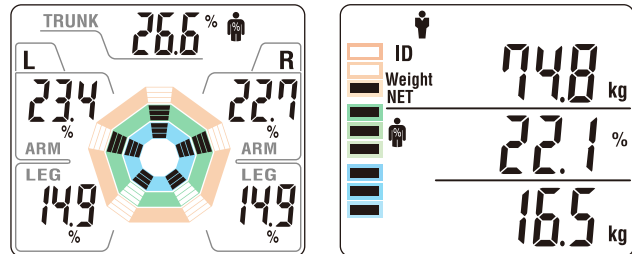

Data Storage

Data storage of measurement results

The results are saved to the SD card immediately after measurement is completed.

The  mark is displayed when a valid SD card is installed.

A new file is created on the SD card for each day.

The file is created using the measurement date and time as the file name, as shown below. "YYYYMMDD" (year, month and date)

If "error 12" is shown in the display, this indicates that there is not enough free space left on the SD card.



You can store approximately 10,000 measurement results (weight only mode) on a 2GB SD card.

- Do not remove the SD card when it is storing or reading data.
- Do not turn off the main power when the SD card is storing or reading data.

Printing Data

Printing Measurement Results

The results are printed from the printer immediately after measurement is completed. The number of sheets that are printed is set in .

Press the  key to print additional copies. You can print out the result if  is lighted.

Output and Storage of Measurement Results (continued)

GB

Reading stored measurement result data

Loading, displaying and printing stored measurement result data

Select the file that you want to load using the  key, and press .

You can also use the number key pad to enter the file name.

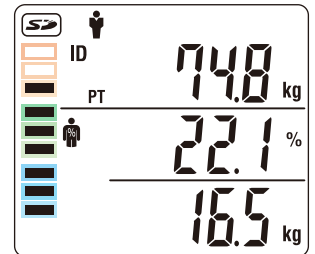
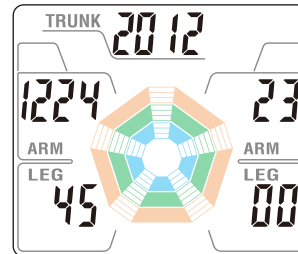

The selected file is displayed on the right side of the LCD.
The file name is displayed as shown below:
Top of the LCD: "yyyy". Centre of the LCD: "mm dd".

General Instructions for Body Composition Measurement

Athletic Mode

- **Recommended for those who are 18 years or older and meet the following conditions.**
 - People who carry out 12 hours or more of cardiovascular exercise a week.
 - People who belong to a sport team or a sport organization with the aim of participation in competition, etc.
 - People who are professional athletes.

Target Body Fat

- **Before you start a weight management program and set the appropriate personal body fat %, please consult your doctor. Tanita is not responsible for setting the appropriate target body fat % for specific individuals.**

Attention

- **Posture when measuring**
 - Stand with both feet parallel on the electrodes.
 - Stand without bending knees.
- **The age input range is 5 – 99 years old.**
Input age 99 for those who are 100 years or older.

Note

- Inaccurate results may be reported after excessive food/fluid intake, or after periods of intense exercise.
- If clothes weight is input, clothes weight is subtracted from the weight measurements.

Troubleshooting

Please check the following before requesting repair.

	Problem	Solution
Measurement	Error with impedance measurement	<ul style="list-style-type: none"> • Hold the handgrips and electrodes firmly with fingers and palms. • Stand barefoot on the platform for measurement. • If the soles of the feet are dry, use the included dropper to apply about 0.5 ml of water before measurement. • Check the input details.
	Error with zeroing	<ul style="list-style-type: none"> • Turn off the power and remove anything on the platform, then turn on the power and try measuring again.
	The weight value does not stabilize.	<ul style="list-style-type: none"> • Is the equipment placed on a vibrating surface? • Is the measuring platform tilted? • Is something blocking the gap in the measuring platform? • Remove any inserted objects.
Display	Nothing is displayed, even when the power is turned on.	<ul style="list-style-type: none"> • Confirm that the power is connected correctly.
	"-----" is displayed.	<ul style="list-style-type: none"> • The measured weight exceeds weighing capacity.

If Necessary
(cautions for safety)

Specifications

GB

If Necessary
(cautions for safety)

Model Number		MC-780MA
Accuracy Grade		MDD: CLASS IIa NAWI: CLASS III
Power Source		100 - 240V AC
Electric Current Range		18VA
Impedance Measurement	Measurement System	Multi-Frequency 8 Electrode
	Measurement Frequency	5kHz/50kHz/250kHz
	Measurement Current	Up to 90μA
	Electrode Materials	Feet: Stainless steel/Handgrips: plated
	Measurement Part	Whole body/Right arm/Left arm/Right leg/Left leg
	Measurement Range	75.0Ω - 1,500.0Ω (0.1Ωincrements)
	Accuracy at First Calibration	± 2%
Weight Measurement	Measurement System	Strain Gauge Load Cell
	Maximum Capacity	270kg (including preset tare value)
	Minimum Graduation	0.1kg
	Accuracy at First Calibration	± 0.2kg
Display		Dual LCD screen
Interface		USB B-type connector (device)
		RS-232C
		USB mini-B (for PictBridge printer)
		SD card*4
Usage Conditions	Temperature	5°C – 35°C
	Relative humidity	30% - 80% (without condensation)
Product Weight		15.5kg
Product Size	Platform	Platform size: 360mm x 360mm Height: 94mm
	Product Height	1165mm

Input items	Clothes Weight		0 - 10.0kg (0.1kg increments)
	Serial No.		Up to 16 digits
	Gender		Female/Male
	Body Type		Standard/Athletic* ¹
	Age		5 - 99 years
	Height		90.0 - 249.9cm (0.1cm increments)
	Target Body fat %		4 - 55% (1% increments)
Output items	ID		16 digits
	Gender		Female/Male
	Body Type		Standard/Athletic* ¹
	Age		5 - 99 years
	Height		90.0 - 249.9cm (0.1cm increments)
	Clothes Weight		0kg - 10.0kg (0.1kg increments)
	Whole Body Analysis	Weight	0kg - 270.0kg (0.1kg increments)
		Fat %	1.0% - 75.0% (0.1% increments)
		Fat Mass*³	(0.1kg increments)
		FFM*³	(0.1kg increments)
		Muscle Mass*³	(0.1kg increments)
		BMI	(0.1 increments)
		Bone Mass*^{2*3}	(0.1kg increments)
		Metabolic Age*²	
		Basal Metabolic Rate*²	(1kcal/1kJ increments)
		Visceral Fat Rating*²	1 - 55 (1 increments)
		TBW*³	(0.1kg increments)
		TBW %	(0.1% increments)
		ECW*²	(0.1kg increments)
		ICW*²	(0.1kg increments)
	ECW / TBW*²	(0.1% increments)	
	Segmental Analysis	Muscle Mass*³	(0.1kg increments)
		Muscle Mass Rating*²	-4 - +4 (1 increments)
		Fat %	(0.1% increments)
		Fat Mass*³	(0.1kg increments)
		Fat Rating*²	-4 - +4 (1 increments)
	Body Balance Evaluation	Physique Rating*²	
Muscle Mass Balance*²			
Leg Muscle Score*²			
Others	Bioelectrical data	Reactance/Resistance/Phase Angle	

*1 Athletic mode can be selected only for ages 18-99.

*2 18-99 years

*3 Calculated value

*4 Compatible with SD and SDHC memory cards

Note

Not compatible with SDXC memory cards

CE 0122 This product meets the following requirements ;
0123 1. Non-Automatic Weighing Instruments (2009/23/EC)
2. Medical Device Directive (93/42/EEC)
3. RoHS Directive (2011/65/EU)

Disposal

 This equipment is an electronic device. Please therefore dispose of it as an electronic device instead of as general household waste. Please follow regional regulations for disposal.

<EU representative>

TANITA® Europe B.V.

Hoogoorddreef 56-E, 1101 BE Amsterdam, The Netherlands Tel: +31-20-560-2970 Fax: +31-20-560-2988 <http://www.tanita.eu>

<Manufacturer>

TANITA® Corporation

1-14-2, Maeno-cho, Itabashi-ku, Tokyo, Japan Tel: +81 (0) 3-3968-7048 Fax: +81 (0) 3-3967-3766 <http://www.tanita.co.jp>

TANITA Corporation of America, Inc.

2625 South Clearbrook Drive,
Arlington Heights, Illinois 60005, U.S.A.
Tel : +1-847-640-9241
Fax: +1-847-640-9261
<http://www.tanita.com>

TANITA Health Equipment H.K.LTD.

Unit 301-303, Wing On Plaza, 3/F., 62 Mody Road,
Tsimshatsui East, Kowloon, Hong Kong
Tel : +852-2834-3917
Fax: +852-2838-8667
www.tanita.asia

TANITA India Private Limited

A-502, Mittal Commercial, Off. M. V. Road (Andheri Kurla Road),
Marol, Andheri-East, Mumbai 400 059 INDIA
Tel : +91-22-3192-6107
Fax: +91-22-2859-9143
www.tanita.co.in

TANITA (Shanghai) Trading Co., Ltd.

Room 8005, 877 Huai Hai Zhong Lu, Shanghai,
People's Republic of China
Tel : +86-21-6474-6803
Fax: +86-21-6474-7901
www.tanita.com.cn